

## Pushbutton

Types Compact 2 Micro US90-EN and US91-EN

Publication Number PB138/0508

### Application

Dewhurst illuminated legend pushbuttons ensure a bright wide angle view in all lighting conditions and are tactile to aid the visually impaired. Compact 2 Micro is ideal for use in all types of lifts and similar installations including those which may be exposed to heavy duty or vandalism.

The EN pressel range is available in three background colours. Black for call, door open and door close buttons, yellow for alarm and green for the exit floor button in the lift car.

### Operation

Operation of the pressel activates a patented switch technology called PushGate™, a revolutionary magnet switch, having no parts that can fatigue. Illumination of the LED illuminator produces a halo of light between the pressel and its bezel via the patented hidden recess that encircles the pressel and illuminates the legend. Standard illumination is by 12V or 24V LED illumination. Single and dual illumination options are available - Single = full brightness, Dual = dim brightness and full brightness.

### Installation

The pushbutton is securely held to the back of the faceplate by 2 off M4 x 16LG weldstuds, washers and nuts.

Compact 2 Micro Pushbuttons can be supplied loose, or incorporated into stations with 1.5mm or 2.5mm stainless steel faceplates, with a vertical pitch of 50mm\*\* or 57mm\*\* and horizontal pitch of 60mm. If pushbuttons are supplied loose, spacers are provided to accommodate the differing faceplate thickness.

\*\*Dependant on connector orientation.

### Technical details

Weight	60grms
Moulded in	high grade polycarbonate
Environmental protection	IP54 (frontal presentation)
Pressel plate material	anodized aluminium (black, green, yellow)
Pressel plate area	US90-EN = 620mm <sup>2</sup> , US91-EN = 707mm <sup>2</sup>
Button force	5N
LED Current	20mA (typically)
LED Colours	Single & dual - red, green, blue, white, yellow. Bi-colour - white/blue & white/red
LED Voltage	12/24V a.c./d.c. ±15%
Various connector options available (AMP-HE14 & MTA100, JST-XH, Camden Screw)	

Designed to meet the requirements of BS CECC 96400:Pushbutton switches where relevant, EN81-1/2, EN81-70 and EN81-71 (Category 1).

### Rating

30V d.c. at 50mA max. resistive loads - min. no. of operations :	5 x 10 <sup>6</sup>
24V d.c. at 20mA max. resistive loads - min. no. of operations :	5 x 10 <sup>6</sup>
12V d.c. at 5mA max. resistive loads - min. no. of operations :	5 x 10 <sup>6</sup>
Power	2.5 watts (max.)
Contact arrangements	1 N/O***

\*\*\*For other contact arrangements or higher ratings, use either a Compact 2 Pushbutton or a Compact 2 Micro Relay Board (e.g. Alarm, Door Open, Door Closed, etc.). Please refer to PB111/PB137 for Compact 2 and PB140 for the Relay Board.

### Marking





A large range of legends in Helvetica Medium characters and symbols are available, please refer to our website.

Tactile legends are formed during the moulding of the pressel body and are in opal 15mm high characters.

PushGate™ technology is a patented design of 

Patent Nos: US PAT nos. 5,523,730; 5,666,096; 5,867,082; 5,990,772; 6,130,593; 6,069,545; 6,023,213; 6,069,552; 6,137,387; 6,262,646 Chinese PAT no. ZL96110385.X Taiwanese PAT No. NIO90979 Australian PAT No. 727962 UK Patent Pending.

**Dewhurst plc** t +44 (0)20 8607 7300 f +44 (0)20 8572 5986 info@dewhurst.co.uk www.dewhurst.co.uk  
Contact your local sales office:

<b>Australia</b>	 Australian lift components	t 02 9603 0200	f 02 9603 2700	info@alc.au.com	www.alc.au.com
	 lift material	t 02 9310 4288	f 02 9698 4990	info@liftmaterial.com	www.liftmaterial.com
<b>Canada</b>	 dupar controls	t 519 624 2510	f 519 624 2524	info@dupar.com	www.dupar.com
<b>UK</b>	 LiftStore	t 020 8538 1770	f 020 8538 1771	info@liftstore.com	www.liftstore.com
<b>USA</b>	 the fixture company	t 847 214 3100	f 847 214 2771	info@thefixtureco.com	www.thefixtureco.com

Surrounds available in Chrome or Green (standard)

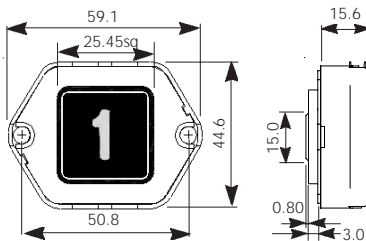

US90-EN

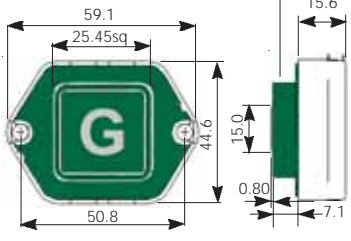

US90-EN (EXIT FLOOR)

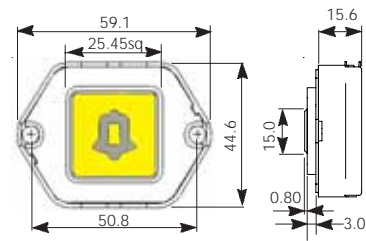

US90-EN ALARM

Surrounds available in Chrome or Green (standard)

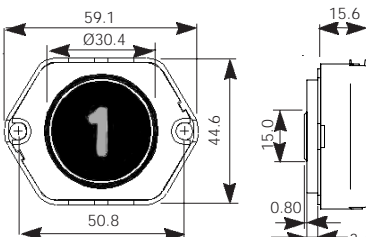

US91-EN

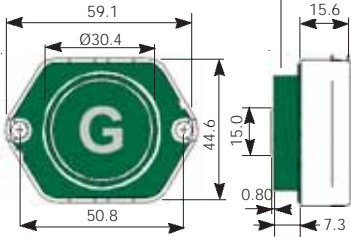

US91-EN (EXIT FLOOR)

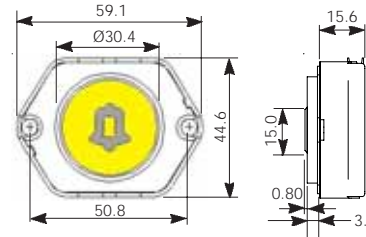

US91-EN ALARM

HORIZONTAL TYPE CONNECTORS

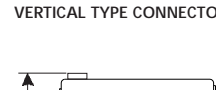
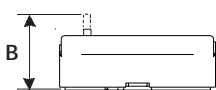
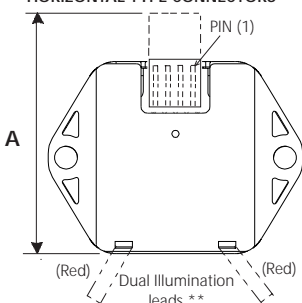

All dimensions in mm

CIRCUIT TYPE

TYPE I	TYPE II	TYPE III	DUAL ILLUMINATION **
<p>XH ( 3 WAY) [SCHINDLER] OR SCREW ( 3 WAY)</p>	<p>XH ( 4 WAY) OR SCREW ( 4 WAY) OR MTA100 ( 4 WAY) [THYSSEN]</p>	<p>HE14 ( 4 WAY) [OTIS]</p>	<p>For dual illumination, connect the two red leads from the body to a permanent power supply. Voltage same as full illumination (not polarity sensitive).</p>

CONNECTOR OPTIONS (ON BUTTON PCB)

TYPE	ORIENTATION <small>Landing buttons have horizontal connectors All other buttons have vertical connectors</small>	NO. OF PINS	VENDOR PART N°	DEWHURST CODE	VENDOR	CIRCUIT TYPE	DIMENSIONS		RECOMMENDED FEMALE CONNECTOR*		
							A	B	VENDOR PART N°	VENDOR	
XH	HORIZONTAL (90°)	3 WAY	S 3B-XH-A	JST3	JST	I	53	-	NR(0*NR-E6S) or HR(0*HR-65) or NRB(0*NR-D6S) * Insert 3 for 3-way or 4 for 4-way	JST	
		4 WAY	S 4B-XH-A	JST4		II	53	-			
	VERTICAL (0°)	3 WAY	B 3B-XH-A	JST3		I	-	23			
		4 WAY	B 4B-XH-A	JST4		II	-	23			
HE14	HORIZONTAL	4 WAY	0281695-4	AMP4	AMP	III	55	-	0281786-4(180°) or 0281711-4(90°)	AMP	
	VERTICAL	4 WAY	0281698-4	AMP4		III	-	32			
MTA100	HORIZONTAL	4 WAY	640457-4	MTA4		II	54	-	640442-4(END) or 640622-4 (THROUGH)		AMP
	VERTICAL	4 WAY	640456-4	MTA4		II	-	30			
SCREW	HORIZONTAL	4 WAY	CBT0305/4	SCR4	CAMDEN	II	-	18	N/A	N/A	
		3 WAY	CBT0305/3	SCR3		I	-	18			

\*Other connector part numbers are available for different arrangements and cable sizes.

PART NUMBER ORDERING

Example  
US91-15C2M - SS / SCR4-R-24L =

STYLE = Round, tactile and Braille  
FINISH = Stainless Steel finish  
PCB = SCR4 connector 24V LED's Red Single illumination

PRESSEL		
STYLE		FINISH
C2M	-	
89	= Barrel, tactile	SS = Stainless Steel
90	= Square, flush	MS = Mirrored Steel
90-15	= Square, tactile & Braille	SB = Standard Brass
91	= Round, tactile	MB = Mirrored Brass
91-15	= Round, tactile & Braille	

PCB		
CONNECTOR TYPE	LEGEND COLOUR	INDICATION
-	-	-
SCR4	R = Red	24L = 24V LED
SCR3	G = Green	12L = 12V LED
JST4	B = Blue	24D = 24V Dual
JST3	W = White	12D = 12V Dual
AMP4	Y = Yellow	24I = 24V Bi-colour
MTA4	W/B = White/Blue	- (only avble screw)
	W/R = White/Red	

## Cutouts and stud positions

### US90

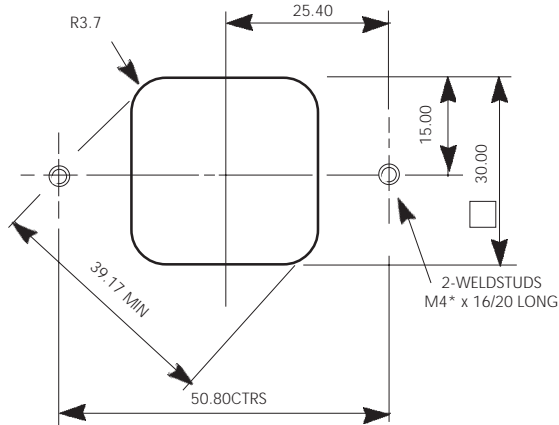

\* 2-WELDSTUDS  
M4 X 16 LONG FOR COMPACT 2 MICRO  
PUSHBUTTONS

### US91

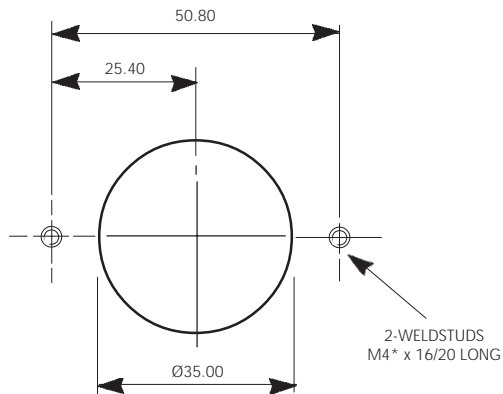

**Dewhurst plc** t +44 (0)20 8607 7300 f +44 (0)20 8572 5986 info@dewhurst.co.uk www.dewhurst.co.uk  
Contact your local sales office:

<b>Australia</b>	<b>D</b> Australian lift components	t 02 9603 0200	f 02 9603 2700	info@alc.au.com	www.alc.au.com
	<b>D</b> lift material	t 02 9310 4288	f 02 9698 4990	info@liftmaterial.com	www.liftmaterial.com
<b>Canada</b>	<b>D</b> dupar controls	t 519 624 2510	f 519 624 2524	info@dupar.com	www.dupar.com
<b>UK</b>	<b>D</b> LiftStore	t 020 8538 1770	f 020 8538 1771	info@liftstore.com	www.liftstore.com
<b>USA</b>	<b>D</b> the fixture company	t 847 214 3100	f 847 214 2771	info@thefixtureco.com	www.thefixtureco.com