

US95-AB White Jumbo Pushbutton

The US95-AB Jumbo braille Pushbutton is manufactured with antimicrobial protection to help prevent the unwanted growth of harmful bacteria. Bacteria can multiply on lift pushbuttons every twenty minutes. This technology makes the product surface hostile to microscopic organisms, making them unable to grow and reproduce. The extra-large pressel is primarily designed for use in larger buildings such as hospitals, airports and shopping centres.

The pushbutton is made up of four elements: switch body, illumination, pressel, and surround. This data sheet includes information on each element and the options available.

Image shows US95-AB Jumbo pushbutton with Jumbo switch body, white antimicrobial plastic pressel and chrome surround. Legend illuminated in blue.



Switch body

The switch body is the functional part of the pushbutton. The US95-AB Jumbo is available with the Jumbo and Jumbo P switch bodies.

Pressel

The pressel is the faceplate of the pushbutton. The US95-AB White Jumbo pressel is made out of plastic which uses silver ion antimicrobial technology. Green and yellow material finishes are available for exit floor and alarm buttons. They are moulded with opal polycarbonate.

There is an extensive range of pressel legends to choose from. All legends are 30mm high and tactile, with standard English braille dots below.

Illumination

Single, dual, bicolour and bicolour+ LED illumination options are available for the US95-AB Jumbo. These illuminate both the legend and the halo. They are easily replaceable and available in blue, white, red, amber and green.

Surround

The surround is the element of the pushbutton which sits in front of the pressel and clicks into the switch body.

US95-AB Jumbo pushbutton surrounds are chrome and available in a wide variety of depths.

Key features

- Standard pressels are extra-large white plastic, moulded with opal polycarbonate.
- Protection against bacteria such as E-Coli, Staph A, MRSA, and more.
- Pressel uses silver ion antimicrobial technology.
- Legend and halo illumination.
- Vandal resistant - meets EN81-71.
- ISO 22196 antibacterial certification.
- Legends are 30mm high and tactile with braille.

Switch body | Jumbo & Jumbo P

The switch body is the functional part of the pushbutton. Both the Jumbo and Jumbo P switch bodies offer the full range of illumination options as well as all possible contact configurations. They also both accept shunt boards.

Dimensions

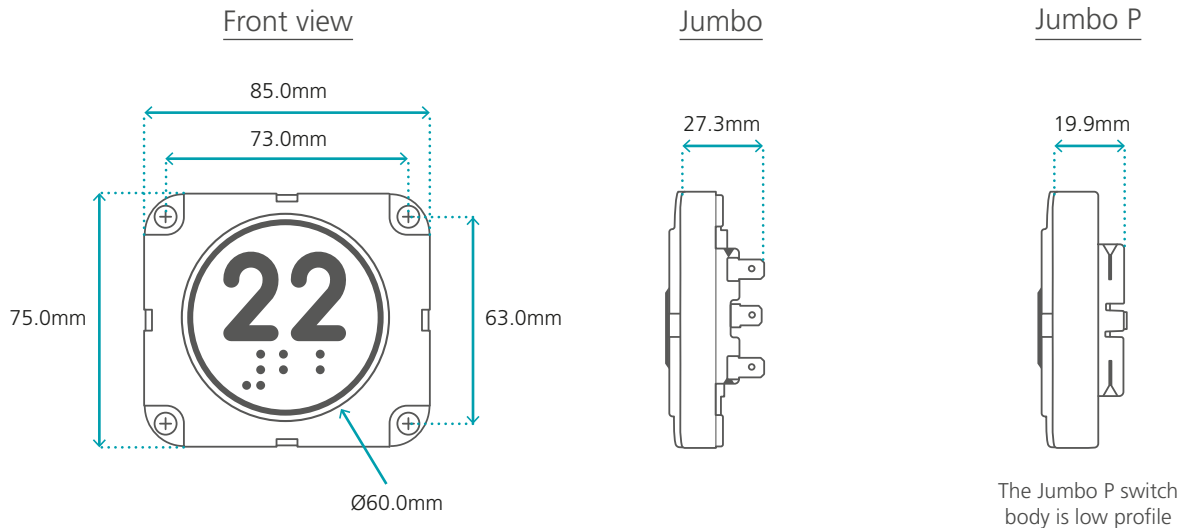

Technical details

Power (continuous)	2.5 watts (maximum)
Contact arrangements	2 Normally Open contacts
	2 Normally Closed contacts
	1 Normally Open contact and 1 Normally Closed contact
Wago cable size	Up to 0.75mm ² solid or flexible (only apply slight pressure when inserting/removing cable)

Environmental protection (IP rating)	EN60529 (IP54)
Vandal resistance	EN81-71
Code compliance	EN81-20, EN81-70

Cutouts & stud positions

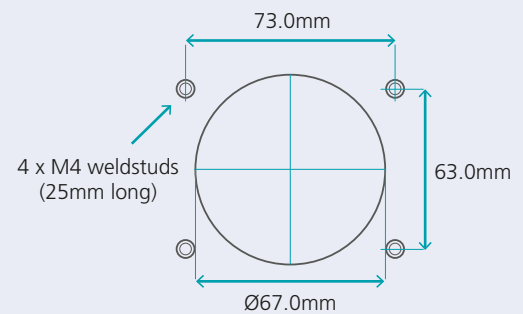

Pushbuttons with Jumbo and Jumbo P switch bodies can be supplied loose or incorporated into stations. These have a vertical pitch of 80mm and horizontal pitch of 90mm, which means the pushbutton body can be rotated 90 degrees.

If the pushbutton is supplied loose, spacers will be provided to accommodate the differing faceplate thickness.

Dewhurst **Jumbo & Jumbo P** switch bodies are designed and tested to last



over **10 million operations.**

Illumination



There are a wide range of interchangeable and easily replaceable LED illumination options available for Dewhurst pushbuttons. All options illuminate both the legend (character or symbol) and the halo (circle of light created between the pressel and the surround).

The US95-AB Jumbo offers a choice of single, dual, bicolour and bicolour+ illumination, all of which are available with Jumbo and Jumbo P switch bodies. LED colours are available in blue, white, red, amber and green.

Single illumination

Before call acceptance	After call acceptance
 <p>Both the legend and the halo are non-illuminated</p>	 <p>The legend and halo are both illuminated at full brightness of any colour</p>

Dual illumination

Before call acceptance	After call acceptance
 <p>Both the legend and the halo are illuminated at 10% of full brightness of any colour</p>	 <p>The legend and halo are both illuminated at full brightness of the same colour</p>

Bicolour illumination

Before call acceptance	After call acceptance
 <p>Both the legend and the halo are illuminated white at 10% of full brightness</p>	 <p>The legend and halo are both illuminated at full brightness of any colour</p>

Bicolour+ illumination

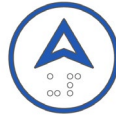
Before call acceptance	After call acceptance
 <p>Both the legend and the halo are illuminated at full brightness of any initial colour</p>	 <p>The legend and halo are both illuminated at full brightness of a different colour</p>

Note: the initial white illumination before call acceptance is still visible after call acceptance. This may result in the chosen colour being slightly lighter than full brightness of other illumination options.

Technical details

LED current	20mA (typically)
LED voltage ($\pm 15\%$)	12V DC, 24V DC, 110V AC

Pressel

The pressel (the faceplate of the pushbutton) is manufactured using silver ion antimicrobial technology to help prevent the unwanted growth of harmful bacteria. The antibacterial protection is designed to last the lifetime of the product and will not wash out or wear away.

The US95-AB Jumbo pressel offers an extensive range of pressel legends to choose from. All legends are 30mm high and tactile, with standard English braille dots below.

Material finishes

White plastic with antimicrobial protection



Green plastic with antimicrobial protection

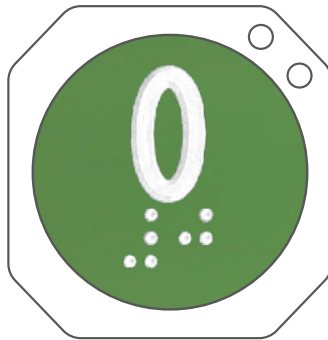

Yellow plastic with antimicrobial protection

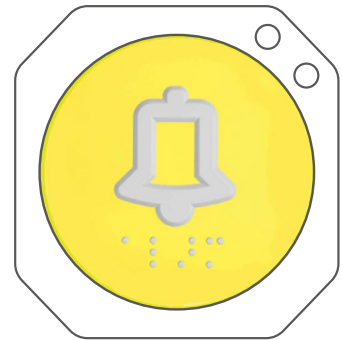

Standard US95-AB Jumbo pressels are moulded with opal polycarbonate, but other colours are available on request.

Surround

The surround is the element of the pushbutton which sits in front of the pressel and clicks into the switch body. Dewhurst pushbutton surrounds are available in a wide variety of material, depth and colour.

Material finishes

Standard material finishes include clear plastic, chrome, brass, satin chrome, black and green.

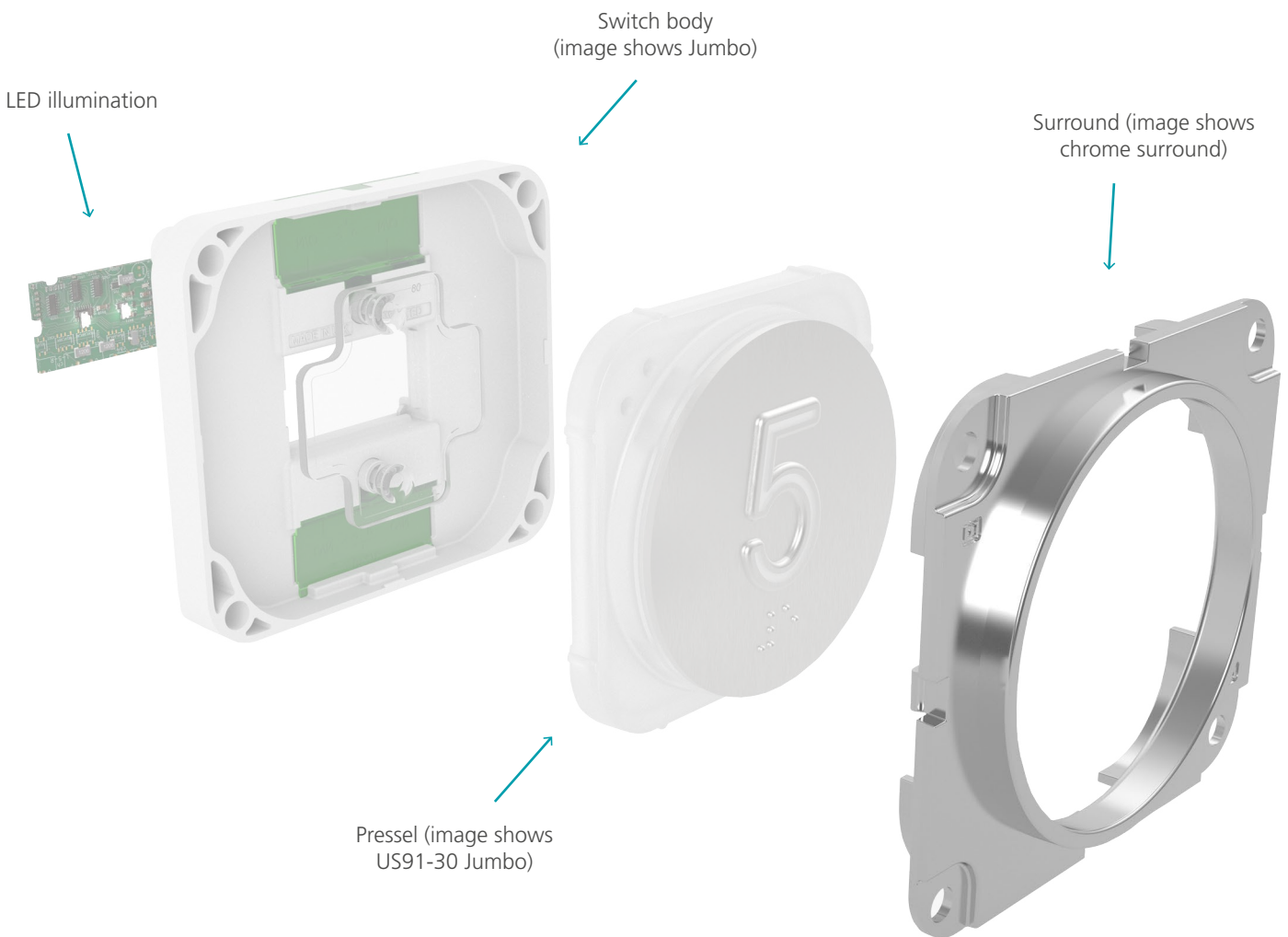

Surround depths

All measurements are the protrusion through the faceplate.

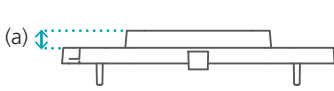
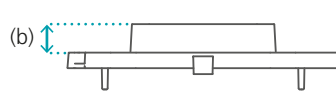
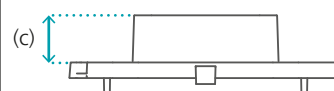
Standard	B44	Exit
		
(a) 3mm	(b) 4.6mm	(c) 7.1mm

Cleaning your Dewhurst pushbutton

Many Dewhurst lift products are made of polycarbonate (Using GE's Lexan® or Bayer's Makrolon®). The US95-AB Jumbo is highly durable and vandal resistant, but plastic parts can be damaged by aggressive cleaning agents.

Recommended guidance



Clean with a **cotton cloth** and **warm water** before applying the cleaning product.



Use **PH-neutral** or slightly acid cleaning products only (including aromatised ones).



Ethylic alcohol, isopropyl alcohol or ethylene glycol based multipurpose cleaning products and dish soaps are suggested. Dilute the cleaning product in warm water and apply using a wet cotton cloth.



Grease, glue and paint may be removed with **ethylic alcohol or isopropyl alcohol**.

DO NOT USE

- ✗ Abrasive cleaning agents
- ✗ Cleaning agents at high temperatures
- ✗ Antibacterial detergent
- ✗ Sharp tools to remove dirt (chewing gum, glue, etc.)
- ✗ Solvents based with Ketones, benzene, methanol, toluene (methylbenzene or phenyl methane)
- ✗ Alkaline and ammonia based cleaning agents or ones containing citrus

DO NOT leave cleaning agents on the parts for long periods of time: remove immediately after cleaning using a damp cotton cloth.